

Schneidringverschraubung

Cutting ring connection

SV

Schneidringverschraubung ISO 8434-1 (DIN 2353)

Gewindezapfen DIN 3853, Bohrungsform W DIN 3861
Anstelle des Schneidringes ist auch eine Anschweiß-
kugelbuchse möglich (siehe Schweißnippelanschlüsse, S. A16)

Cutting ring connection according to ISO 8434-1 (DIN 2353)

Male thread according to DIN 3853 spec.
Bore: form W according to DIN 3861 spec.
(instead of the cutting ring, there is a welding nipple possible, page A16)

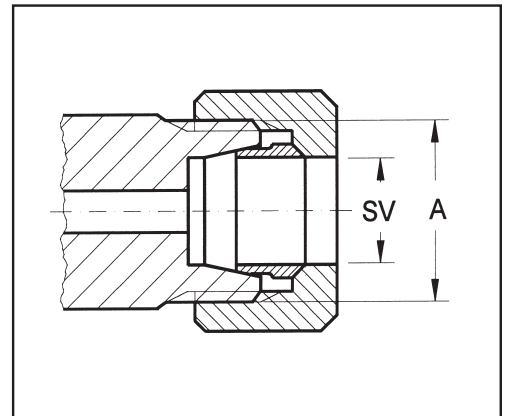

Schwere Reihe / heavy series

Ventiltyp / type of valve

SV =O.D.	A	PN	Code	Ventiltyp / type of valve					
				A3	A7	A11	E5	S15 Eing./in	S15 Ausg./out
6	M14x1,5	400	SV 6	●	●	●	●	●	●
8	M16x1,5	400	SV 8	●	●	●	●	●	●
10	M18x1,5	400	SV 10	●	●	●	●	●	●
12	M20x1,5	400	SV 12	●	●	●	●	●	●
14	M22x1,5	400	SV 14	●	●	●	●	●	●
16	M24x1,5	400	SV 16		●	●	●	●	
20	M30x2	400	SV 20			●		●	
25	M36x2	400	SV 25			●			

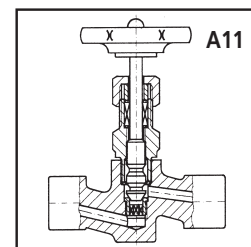
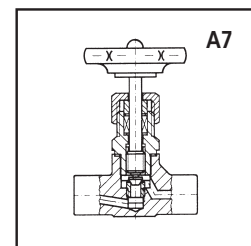
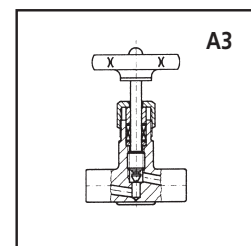

Leichte Reihe / light series

Ventiltyp / type of valve

SV =O.D.	A	PN	Code	Ventiltyp / type of valve					
				A3	A7	A11	E5	S15 Eing./in	S15 Ausg./out
6	M12x1,5	250	SV 6l	●	●	●	●	●	●
8	M14x1,5	250	SV 8l	●	●	●	●	●	●
10	M16x1,5	250	SV 10l	●	●	●	●	●	●
12	M18x1,5	250	SV 12l	●	●	●	●	●	●
15	M22x1,5	250	SV 15	●	●	●	●	●	●
18	M26x1,5	160	SV 18		●	●	●	●	
22	M30x2	160	SV 22			●		●	
28	M36x2	100	SV 28			●			

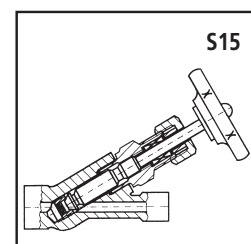
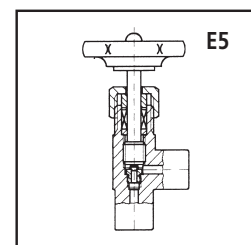

► Zöllige O.D. Maße auf Anfrage
Inch-O.D.-dimensions on request

Klemmringverschraubung

Twin ferrule compression fitting

KL

Klemmringverschraubung

Unsere Armaturen können sowohl mit den Anschlußmaßen für Schneidring-, als auch Klemmringverschraubungen gefertigt und mit den Originalteilen (Mutter, vorderer und hinterer Klemmring) verschiedener Hersteller geliefert werden.

Twin ferrule compression fitting

Instead of the dimensions of cutting ring unions we can fabricate the dimensions of twin ferrule unions. They can be delivered with the original parts (nut, two clamp rings) of different manufactures.

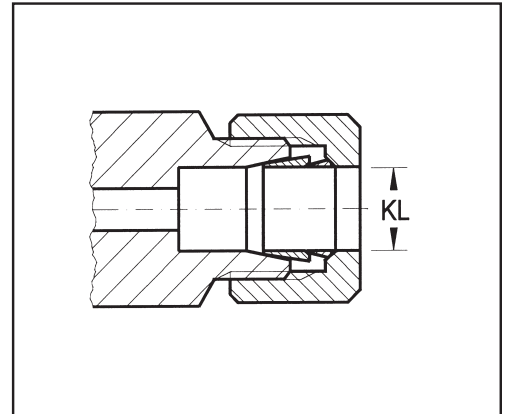

Schwere Reihe / heavy series Ventiltyp / type of valve

KL =O.D.	PN	Code	Ventiltyp / type of valve					
			A3	A7	A11	E5	S15 Eing./in	S15 Ausg./out
6	400	KL 6	•	•	•	•	•	•
8	400	KL 8	•	•	•	•	•	•
10	400	KL 10	•	•	•	•	•	•
12	400	KL 12	•	•	•	•	•	•
14	400	KL 14	•	•	•	•	•	•
15	400	KL 15	•	•	•	•	•	
16	400	KL 16		•	•	•	•	
18	400	KL 18		•	•	•	•	
20	400	KL 20			•		•	
25	400	KL 25			•		•	
1/8"	400	KL 1/8	•	•	•	•	•	•
3/16"	400	KL 3/16	•	•	•	•	•	•
1/4"	400	KL 1/4	•	•	•	•	•	•
5/16"	400	KL 5/16	•	•	•	•	•	•
3/8"	400	KL 3/8	•	•	•	•	•	•
1/2"	400	KL 1/2	•	•	•	•	•	•
5/8"	400	KL 5/8		•	•	•	•	
3/4"	400	KL 3/4		•	•	•	•	
7/8"	400	KL 7/8			•		•	
1"	400	KL 01			•		•	

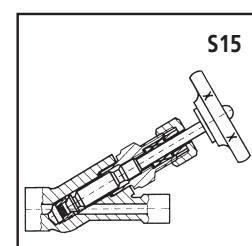
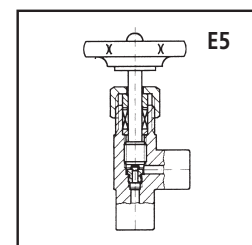
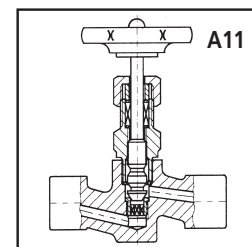
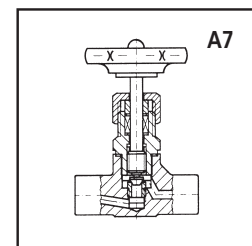
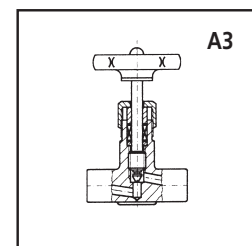

▶ weitere O.D. Maße auf Anfrage
more O.D.-dimensions on request

Schweißnippel

Welding nipple

SK / SN

Schweißnippelanschlüsse

Kugelbuchse, passend zum Schneidringanschluß nach ISO 8434-1 (DIN 2353) oder Schweißnippel nach DIN 19207 oder Schweißnippel nach DIN 16284 (siehe Kapitel Zubehör für Manometerventile, Seite Z5)

Welding nipple (teil nipple) connections

Welding nipple with crowned end, suitable for cutting ring connection according to ISO 8434-1 (DIN 2353) spec. or welding nipple according to DIN 19207 spec. or welding nipple according to DIN 16284 spec. (see chapter accessories for gauge valves, page Z5)



Bild A: Schweißkugelbuchse (PN400) (s. Kapitel Zubehör Seite Z3)
metallisch dichtend

Picture A: Welding nipple (PN400) (s. chapter accessories page Z3)
metal-to-metal seal

Ventiltyp / type of valve

D	d	L	Code	Ventiltyp / type of valve						
				A3	A7	A11	E5	S15E	S15A	
8	4	36	SK 8	●	●	●	●	●	●	
10	6	36	SK 10	●	●	●	●	●	●	
12	8	36	SK 12	●	●	●	●	●	●	
14	8	36	SK 14	●	●	●	●	●	●	

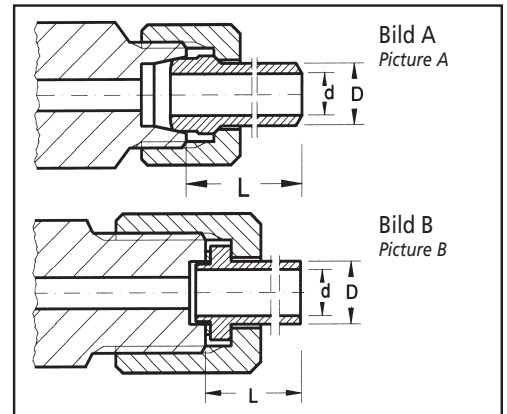
Weitere Abmessungen auf Anfrage
Other dimensions on request

Bild B: Schweißnippel (notwendige Dichtung (s. Kapitel Zubehör Seite Z11) nach DIN 19207, Wst. 1.4571)

Picture B: welding nipple according to DIN 19207 spec. (s. chapter accessories page Z11) with necessary seal according to DIN 19207 spec., mat. 1.4571 (SS) Ventiltyp / type of valve

D	d	L	Code	Ventiltyp / type of valve					
				A3	A7	A11	E5	S15E	S15A
12	8,7	36	SN 12	●	●	●	●	●	●
14	9	36	SN 14	●	●	●	●	●	●

Gewindeanschluss G 1/2" nach DIN 19207 Form R
Thread G1/2" according to DIN 19207 spec., form R

Die Schweißnippel werden aus folgenden Werkstoffen gefertigt:
The materials for the manufacture of welding nipples are as follows:

Armaturenkörperwerkstoff
valve body material

Schweißnippelwerkstoff
welding nipple material

P250GH (1.0460) / 1020	16Mo3 (1.5415) / A182F1
16Mo3 (1.5415) / A182F1	16Mo3 (1.5415) / A182F1
13CrMo34 (1.7335) / A182-F11; F12	16Mo3 (1.5415) / A182F1
X6 Cr Ni Mo Ti 17 12 2 (1.4571) / 316 Ti	X6 Cr Ni Mo Ti 17 12 2 (1.4571) / 316 Ti

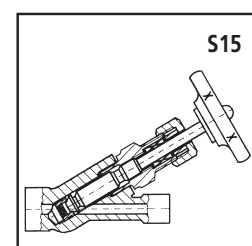
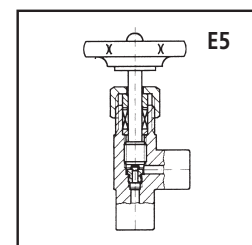
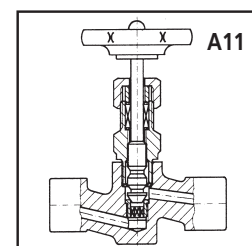
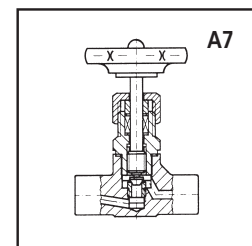
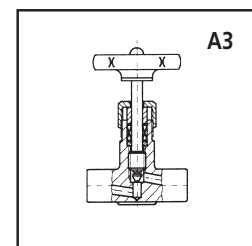

G - Außengewinde

G - Male thread

Zylindrisches Außengewinde

Gewinde nach DIN ISO 228 Teil 1, Rohrgewinde G mit und ohne Dichtbund (andere Dichtformen z.B. Linseneindrehung auf Anfrage)

Parallel male thread, BSP

Thread according to DIN ISO 228 spec. part 1, pipe thread G with and without sealing collar (other forms of sealing, for instance lens-seal on request)

GA

G-Gewinde, ohne Dichtbund, stirnseitig flachdichtend, Gewinde auslaufend
 G-thread, without sealing collar, flat facing, without thread recess

Ventiltyp / type of valve

D	L	Code	Ventiltyp / type of valve					
			A3	A7	A11	E5	S15E	S15A
			<small>Eing./in Ausg./out</small>					
G 1/8"	12	GA 18	●	●	●	●	●	●
G 1/4"	12	GA 14	●	●	●	●	●	●
G 3/8"	16	GA 38	●	●	●	●	●	●
G 1/2"	22	GA 12*	●	●	●	●	●	●
G 5/8"	25	GA 58*		●	●	●	●	
G 3/4"	20	GA 34		●	●	●	●	
G 1"	20	GA 01			●			

*Dieser Anschluß wird entsprechend DIN 19207, Form R gefertigt

*This connection is according DIN 19207, form R

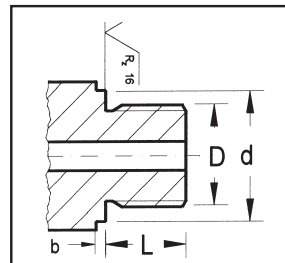

GB

G-Gewinde, mit Dichtbund, Bund plangedreht
 DIN 3852, Teil 2, Form A

G-thread, with sealing collar, DIN 3852 part 2, form A

Ventiltyp / type of valve

D	d	b	L	Code	Ventiltyp / type of valve					
					A3	A7	A11	E5	S15E	S15A
					<small>Eing./in Ausg./out</small>					
G 1/8"	14	2	8	GB 18	●	●	●	●	●	●
G 1/4"	18	2	12	GB 14	●	●	●	●	●	●
G 3/8"	22	2	12	GB 38	●	●	●	●	●	●
G 1/2"	26	2	14	GB 12		●	●	●	●	
G 5/8"	28	3	14	GB 58		●	●	●	●	
G 3/4"	32	3	16	GB 34			●		●	
G 1"	39	3	18	GB 01			●			

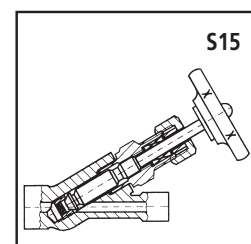
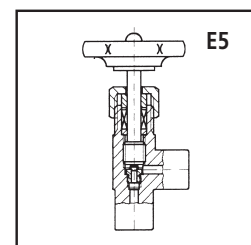
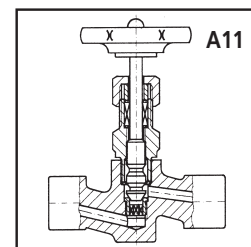
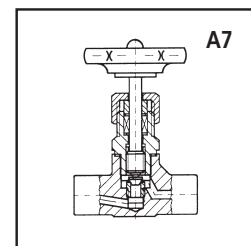
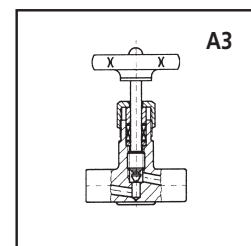
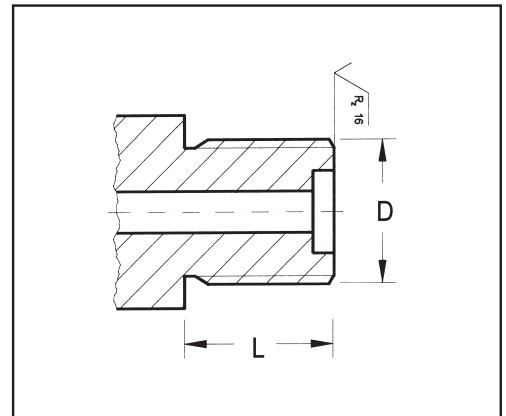

G - Innengewinde

G - Female thread

GI

Innengewinde

Zylindrisches Rohrgewinde G nach DIN 3852, Teil 2 Form Z für Einschraubstutzen Form C. Mit zusätzlicher Planfläche stirnseitig, für Einschraubstutzen Form A,B und E. (Die Dichtung ist in diesem Fall nicht gekammert.)

Parallel female thread

Thread according to DIN 3852 spec. part 2 form Z for stud form C. Additional with facing for stud form A,B and E. (In this case the sealing is not in a recess.)

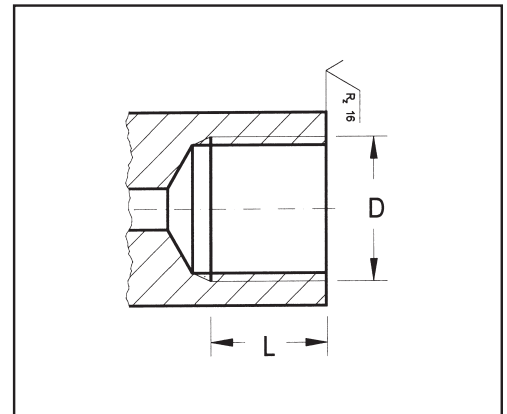

G-Gewinde / G-thread

Ventiltyp / type of valve

D	L min	Code	Ventiltyp / type of valve					
			A3	A7	A11	E5	S15E	S15A
			Eing./in Ausg./out					
G 1/8"	9	GI 18	●	●	●	●	●	●
G 1/4"	14	GI 14	●	●	●	●	●	●
G 3/8"	14	GI 38	●	●	●	●	●	●
G 1/2"	17	GI 12		●	●	●	●	
G 5/8"	19	GI 58			●		●	
G 3/4"	19	GI 34			●		●	
G 1"	21	GI 01			●			

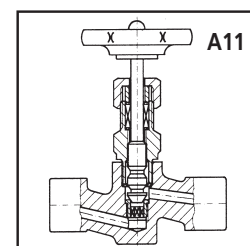
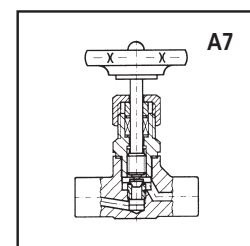
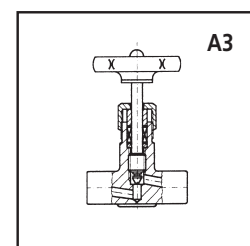
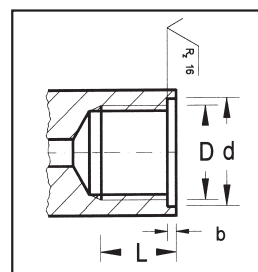

GE

G- Gewinde mit Eindrehung DIN 3852 Teil 2, Form X für Einschraubzapfen Form A, B, C und E

G- thread DIN 3852 part 2, form X for stud form A, B, C and E

Ventiltyp / type of valve

D	L min	d	b	Code	Ventiltyp / type of valve					
					A3	A7	A11	E5	S15E	S15A
					Eing./in Ausg./out					
G 1/8"	9	15	1	GE 18	●	●	●	●	●	●
G 1/4"	14	19	1,5	GE 14	●	●	●	●	●	●
G 3/8"	14	23	2	GE 38		●	●	●	●	
G 1/2"	17	27	2,5	GE 12		●	●	●	●	
G 5/8"	19	29	2,5	GE 58			●		●	
G 3/4"	19	33	2,5	GE 34			●		●	

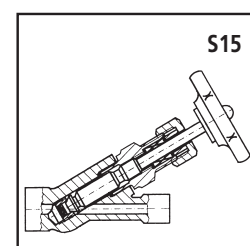
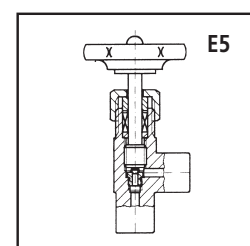

M - Außengewinde

M - Male thread

Metrisches DIN-ISO-Außengewinde

Gewinde nach DIN 13 Teil 6 und Teil 7 mit und ohne Dichtbund (andere Dichtformen z.B. Linseneindrehung auf Anfrage)

Parallel DIN-ISO metric male thread

Thread according to DIN 13 spec. part 6 and 7, pipe thread M with and without sealing collar (other forms of sealing, for instance lens-seal on request)

MA

M-Gewinde, ohne Dichtbund, stirnseitig flachdichtend, Gewinde auslaufend

M-thread, without sealing collar, flat facing, without thread recess

Ventiltyp / type of valve

D	L	Code	Ventiltyp / type of valve						
			A3	A7	A11	E5	S15E	S15A	
M12x1,5	12	MA 12	●	●	●	●	●	●	
M14x1,5	12	MA 14	●	●	●	●	●	●	
M16x1,5	16	MA 16	●	●	●	●	●	●	
M18x1,5	16	MA 18	●	●	●	●	●	●	
M20x1,5	20	MA 20	●	●	●	●	●	●	
M22x1,5	20	MA 22		●	●	●	●	●	
M27x2	20	MA 27			●		●		
M33x2	25	MA 33			●				

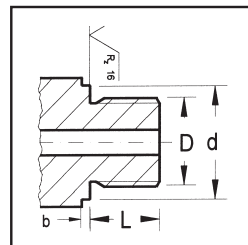
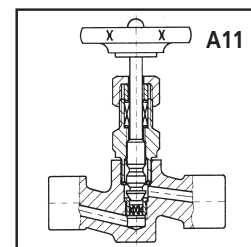
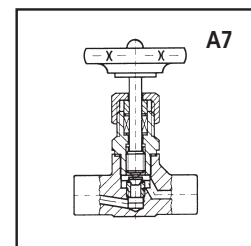
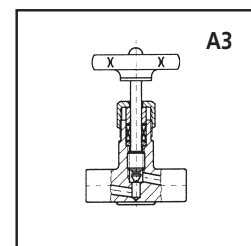
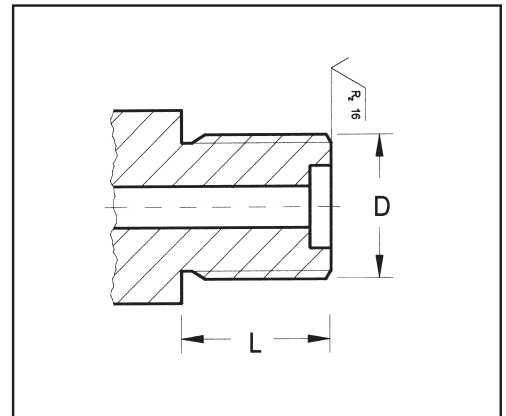

MB

M-Gewinde, mit Dichtbund, Bund plangedreht DIN 3852, Teil 1, Form A

G-thread, with sealing collar, DIN 3852 part 1, form A

Ventiltyp / type of valve

D	d	b	L	Code	Ventiltyp / type of valve					
					A3	A7	A11	E5	S15E	S15A
M12x1,5	17	2	12	MB 12	●	●	●	●	●	●
M14x1,5	19	2	12	MB 14	●	●	●	●	●	●
M16x1,5	21	2	12	MB 16	●	●	●	●	●	●
M18x1,5	23	2	12	MB 18		●	●	●	●	●
M20x1,5	25	2	14	MB 20		●	●	●	●	
M22x1,5	27	2	14	MB 22			●		●	
M27x2	32	3	16	MB 27			●		●	
M33x2	39	3	18	MB 33			●			

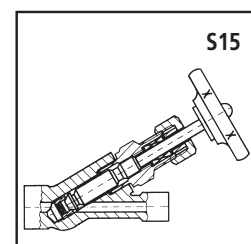
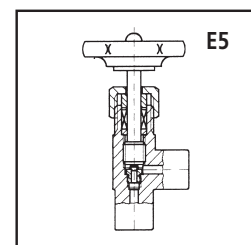

M - Innengewinde

M - Female thread

MI

Innengewinde

Metrisches ISO Feingewinde M nach DIN 3852 Teil 1 Form Z für Einschraubstutzen Form C. Mit zusätzlicher Planfläche stirnseitig, für Einschraubstutzen Form A, B und E. (Die Dichtung ist in diesem Fall nicht gekammert.)

Parallel female thread

Metric ISO fine thread M according to DIN 3852 spec. part 1 form Z for stud form C. Additional with facing for stud form A, B and E. (In this case the seal is not in a recess.)

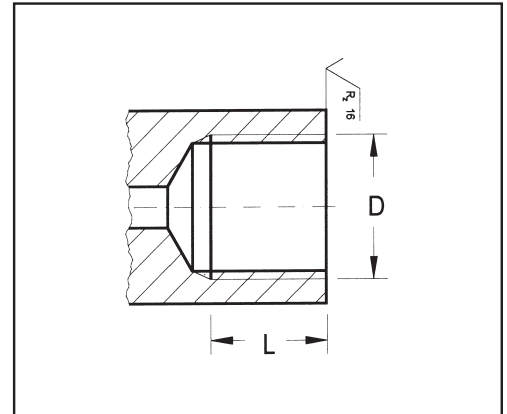

M-Gewinde / G-thread

Ventiltyp / type of valve

D	L _{min}	Code	Ventiltyp / type of valve					
			A3	A7	A11	E5	S15E	S15A
			Eing./in Ausg./out					
M10x1	9	MI 10	●	●	●	●	●	●
M12x1,5	14	MI 12	●	●	●	●	●	●
M14x1,5	14	MI 14	●	●	●	●	●	●
M16x1,5	14	MI 16	●	●	●	●	●	●
M18x1,5	14	MI 18		●	●	●	●	
M20x1,5	17	MI 20		●	●	●	●	
M22x1,5	17	MI 22		●	●	●	●	
M26x1,5	19	MI 26			●		●	
M27x2	19	MI 27			●		●	
M33x2	21	MI 33			●			

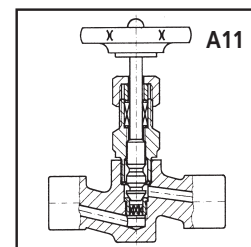
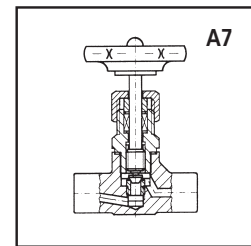
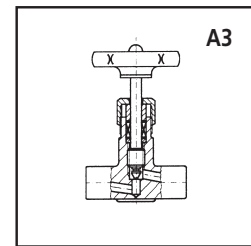

ME

M- Gewinde mit Eindrehung DIN 3852 Teil 1, Form X für Einschraubstutzen Form A, B, C und E

M- thread DIN 3852 part 1, form X for stud form A, B, C and E Ventiltyp / type of valve

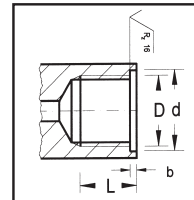

D	L	d	b	Code	Ventiltyp / type of valve					
					A3	A7	A11	E5	S15E	S15A
					Eing./in Ausg./out					
M10x1	9	15	1	ME 10	●	●	●	●	●	●
M12x1,5	14	18	1,5	ME 12	●	●	●	●	●	●
M14x1,5	14	20	1,5	ME 14	●	●	●	●	●	●
M16x1,5	14	22	1,5	ME 16		●	●	●	●	
M18x1,5	14	24	2	ME 18		●	●	●	●	
M20x1,5	17	26	2,5	ME 20		●	●	●	●	
M22x1,5	17	28	2,5	ME 22			●		●	
M26x1,5	19	32	2,5	ME 26			●		●	
M27x2	19	33	2,5	ME 27			●		●	

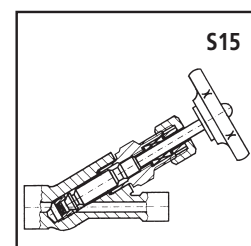
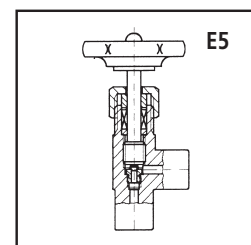

NPT - Außengewinde

NPT - Male thread

NA

NPT - Außengewinde

Amerikanisches kegeliges Rohrgewinde
 ANSI / ASME B1.20.1 - 1983

NPT male thread

American NPT tapered thread
 ANSI / ASME B1.20.1 - 1983

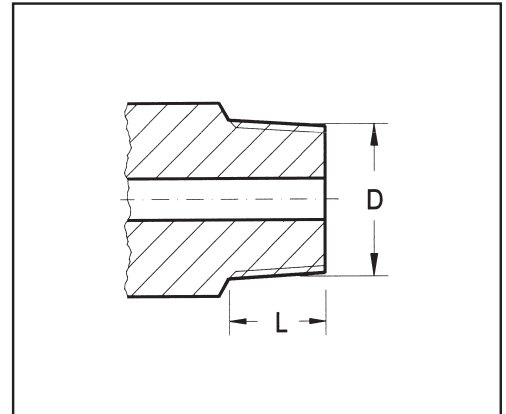

Ventiltyp / type of valve

D	L min	Code	Ventiltyp / type of valve					
			A3	A7	A11	E5	S15E	S15A
			Eing./in Ausg./out					
1/8-27 NPT	8	NA 18	●	●	●	●	●	●
1/4-18 NPT	12	NA 14	●	●	●	●	●	●
3/8-18 NPT	12	NA 38	●	●	●	●	●	●
1/2-14 NPT	14	NA 12	●	●	●	●	●	●
3/4-14 NPT	16	NA 34		●	●	●	●	
1-11.5 NPT	19	NA 01			●		●	

Das NPT-Gewinde ist ein kegeliges Rohrgewinde, welches über die gesamte verschraubte Länge dichtet. Es benötigt jedoch ein zusätzliches Dichtmittel, z.B. Teflonband. Das Band wird stramm (2x im Uhrzeigersinn) auf das äußere Gewinde gewickelt. Es ist nicht nur Dicht- sondern auch Gleitmittel. Nach der Montage bleiben üblicherweise ca. 2 Gänge sichtbar. Beachten Sie die evtl. Einzeinschränkungen aufgrund der Temperaturbeständigkeit des Dichtmittels (z.B. Teflonband max 230°C).

The NPT thread has a tapered form. To ensure a leak-tight seal, the use of a pipe thread sealant is recommended. One commonly utilized technique is Teflon Tape, which you wrap twice clockwise around the male end. Note that the pipe thread sealant may have lower temperature capabilities than the valve (e.g. Teflon Tape max 450°F).

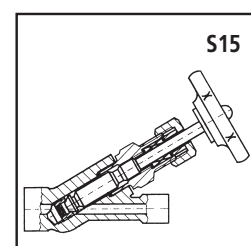
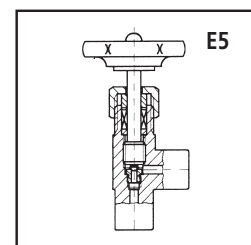
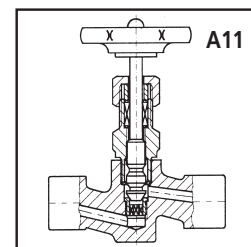
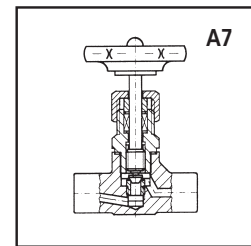
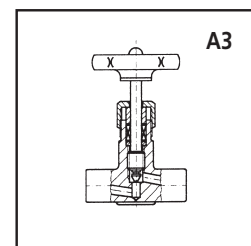

NPT - Innengewinde

NPT - Female thread

NI

NPT - Innengewinde

Amerikanisches kegeliges Rohrgewinde
 ANSI / ASME B1.20.1 - 1983

NPT female thread

American NPT pipe thread
 ANSI / ASME B1.20.1 - 1983

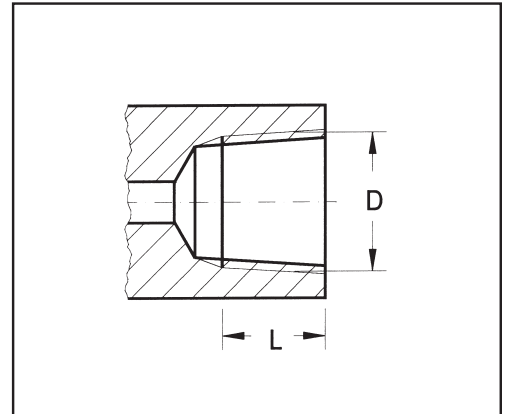

Ventiltyp / type of valve

D	L min	Code	Ventiltyp / type of valve						
			A3	A7	A11	E5	S15E	S15A	
1/8-27 NPT	10	NI 18	•	•	•	•	•	•	•
1/4-18 NPT	11	NI 14	•	•	•	•	•	•	•
3/8-18 NPT	12	NI 38		•	•	•	•		
1/2-14 NPT	15	NI 12		•	•	•	•		
3/4-14 NPT	17	NI 34			•		•		
1-11.5 NPT	19	NI 01			•				

Das NPT-Gewinde ist ein kegeliges Rohrgewinde, welches über die gesamte verschraubte Länge dichtet. Es benötigt jedoch ein zusätzliches Dichtmittel, z.B. Teflonband. Das Band wird stramm (2x im Uhrzeigersinn) auf das äußere Gewinde gewickelt. Es ist nicht nur Dicht- sondern auch Gleitmittel. Nach der Montage bleiben üblicherweise ca. 2 Gänge sichtbar. Beachten Sie die evtl. Einzeinschränkungen aufgrund der Temperaturbeständigkeit des Dichtmittels (z.B. Teflonband max 230°C).

The NPT thread has a tapered form. To ensure a leak-tight seal, the use of a pipe thread sealant is recommended. One commonly utilized technique is Teflon Tape, which you wrap twice clockwise around the male end. Note that the pipe thread sealant may have lower temperature capabilities than the valve (e.g. Teflon Tape max 450°F).

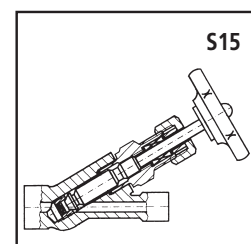
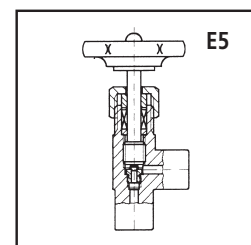
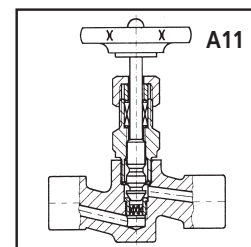
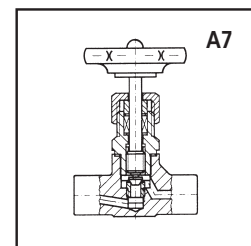
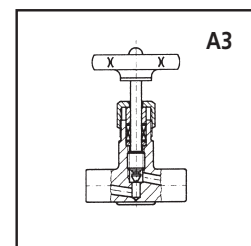

Schweißzapfen

Butt weld ends

SZ

Schweißzapfen

*Fugenform nach EN 12627 (DIN 2559) (s. unten) bis Wandstärke 2mm stumpf (Kennzahl 1), oder bis Wandstärke 16mm in V-Form (Kennzahl 22), oder nach Kundenvorschrift

Butt weld ends

Form of weld ends according to EN 12627 (DIN 2559) spec.; up to 2mm wall thickness butt weld joint (mark 1), or until 16mm wall thickness welding ends in V-form (mark 22), or to clients specification

Ventiltyp / type of valve

D	S	L	Code	A3	A7	A11	E5	S15E	S15A
				Eing./lin					
12	2	7	SZ 12	●	●	●	●	●	●
13,5	2,6	7	SZ 13	●	●	●	●	●	●
14	2,5	7	SZ 14	●	●	●	●	●	●
17,2	2,6	10	SZ 17	●	●	●	●	●	●
20	2,6	10	SZ 20	●	●	●	●	●	●
21,3	2,6	10	SZ 21	●	●	●	●	●	●
21,3	3,2	10	SZ 22	●	●	●	●	●	●
21,3	6,3	10	SZ 23	●	●	●	●	●	●
24	7,1	10	SZ 24		●	●	●	●	
26,9	5	10	SZ 27		●	●	●	●	
33,3	5	10	SZ 01			●		●	

Weitere Abmessungen auf Anfrage

Other dimensions on request

EN 12627 (DIN2559)

Kennzahl	Wanddicke s	Benennung	Sinnbild	Fugenformen Schnitt	α Grad	Maße Stegabstand b	Steghöhe c	Flankenhöhe h
1	bis 3	I-Naht			-	0 bis 3	-	-
22	bis 16	V-Naht	V		40 bis 60 für SG 60 für E und G	0 bis 4	bis 2	-

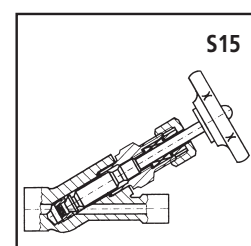
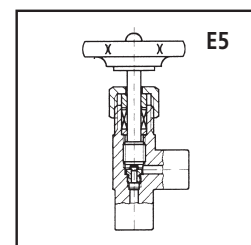
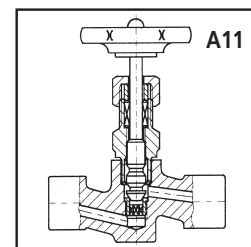
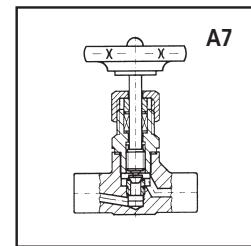
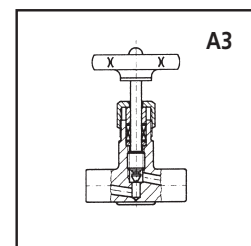
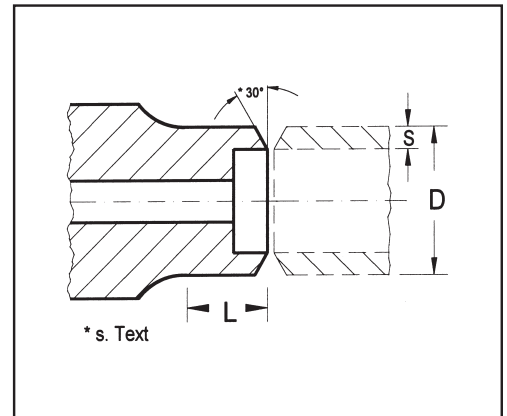

Schweißmuffe

Socket weld ends

SM

Schweißmuffe

In Anlehnung an EN 12760 (DIN 3239 Teil2)

Socket weld ends

Form of weld ends according to EN 12760 (DIN 3239 part 2)

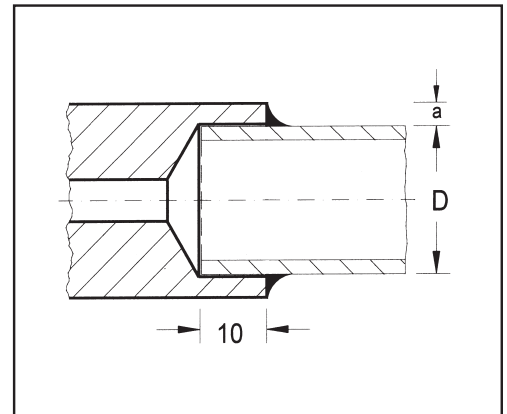

Ventiltyp / type of valve

Rohr außen	D	a min	Code	Ventiltyp / type of valve					
				A3	A7	A11	E5	S15E	S15A
								Eing./in	Ausg./out
12	12,5	5	SM 12	•	•	•	•	•	•
13,5	14	4,3	SM 13	•	•	•	•	•	•
14	14,5	4	SM 14	•	•	•	•	•	•
17,2	18	2,4	SM 17	•	•	•	•	•	•
21,3	22	3,5	SM 21		•	•	•	•	
26,9	27,5	4,3	SM 27			•		•	

Andere Schweißmuffenformen auf Anfrage

Other dimensions on request

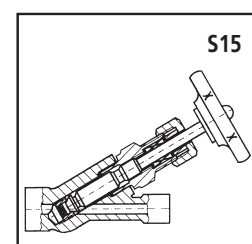
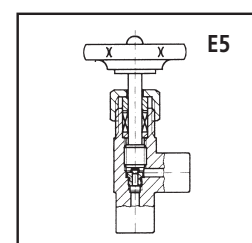
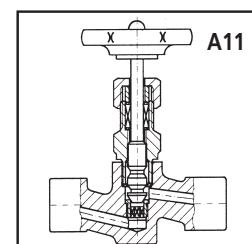
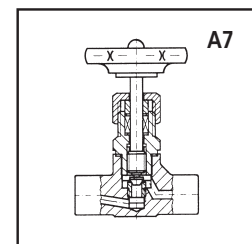
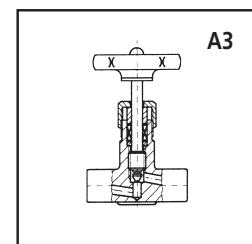

Flanschanschluß

Flange connection

FL

Flanschanschluß

Aufgebohrte, verschweißte Blindflansche nach EN1092-1, alte Norm DIN 2527 oder ANSI B16.5 in diversen Druckstufen mit unterschiedlichen Dichtleisten (s. auch Kapitel Tabellen Seite W8, DIN 2526 - EN1092-1).

Flange connection

Bored, welded blind flanges according to EN1092-1, old no. DIN 2527 spec. or ANSI B16.5 in different pressure ratings and with different facings (s. also chapter table page W8, DIN 2527 - EN1092-1).

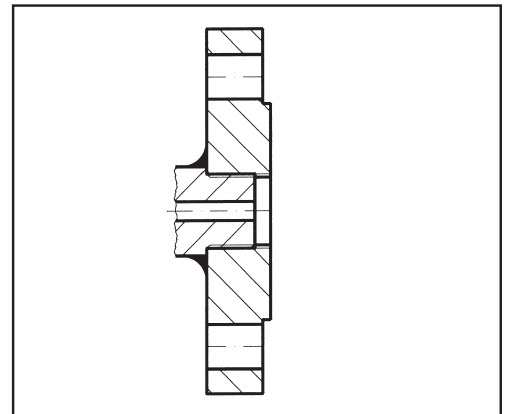

Flansch-Beispiele / flange examples

Ventiltyp / type of valve

DN	PN	Dichtleiste	Code	A3	A7	A11	E5	S15E	S15A
							Eing./in	Eing./in	Ausg./out
15	16	A	FL1516b	●	●	●	●	●	
25	40	B1	FL254	●	●	●	●	●	
25	100	B2	FL2510	●	●	●	●	●	
25	40	D	FL254n	●	●	●	●	●	
25	40	C	FL254f	●	●	●	●	●	
1"	150lbs	RF	FL115	●	●	●	●	●	
1"	600lbs	RTJ	FL160r	●	●	●	●	●	

*Dichtleistenform gemäß EN1092-1 / DIN Types of contact faces according to EN1092-1

► - Bitte geben Sie den Flansch mit Nennweite, Nenndruck und Dichtfläche an
 - please order flanges with DN, PN and facing-form

► - Eine zweite Schweißnaht innen ist auf Wunsch möglich
 - a second welding inside is possible on request

Hinweis

Wenn keine Angaben zur Dichtfläche gemacht werden, liefern wir folgende Ausführungen:

bis PN 100 - Form B1
 ab PN 100 - Form B2
 ANSI Flansch - Form RF

- weitere Dichtflächen gemäß EN1092-1, bzw. ANSI B16.5
- Die sich bei Flanschanschlüssen ergebende Artikelnummer der Armatur kann auf Grund der Länge ggf. gekürzt werden.

Remarks

flanges without specification of the facing

up to PN 100 - form B1
 higher than PN 100 - form B2
 ANSI flanges - form RF

- other facings according to EN1092-1, or ANSI B16.5
- The valve order number may be shortened because of the length of the flange-codes

DIN 2526	EN 1092-1
Form A	Form A
Form B	Form A
Form C	Form B1
Form D	Form B1
Form E	Form B2
Form F	Form C
Form N	Form D
Form V13	Form E
Form R13	Form F
Form V14	Form H
Form R14	Form G

Weitere Informationen Seite W8
 More Information page W8

